

Decoupe passage mats d'entreplan

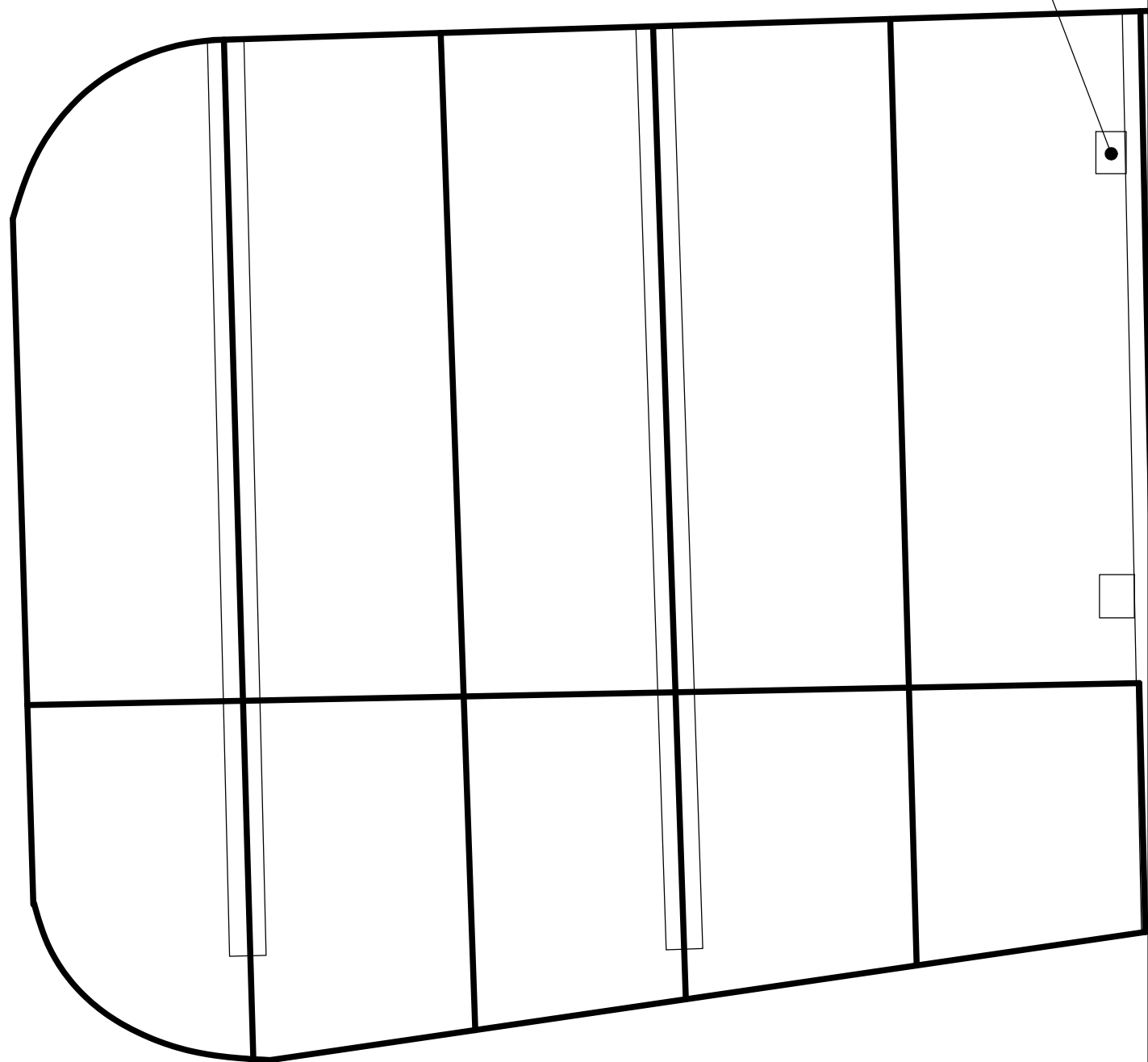

Marquage de



s fausses nervures au stylo bille.

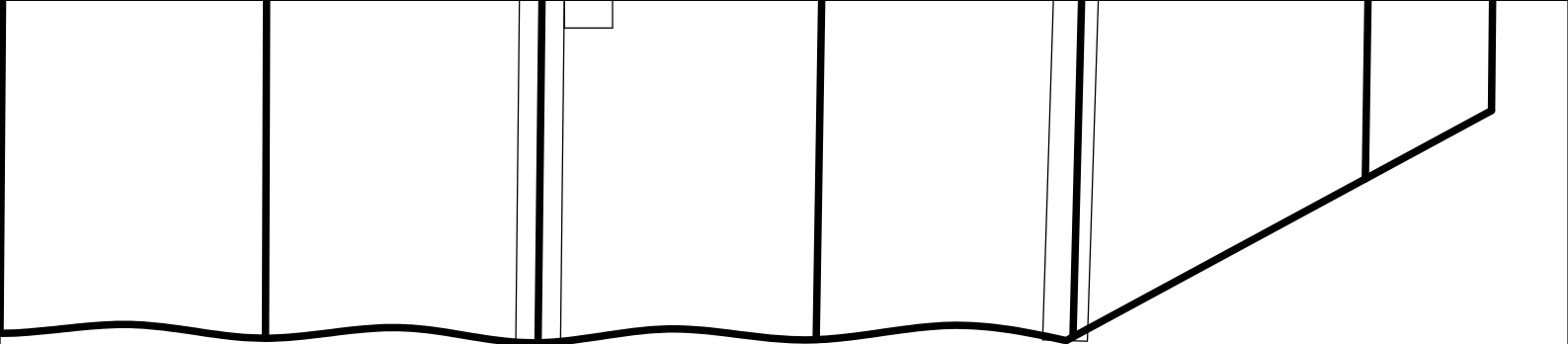

Emplacements des nervures - depron 6mm

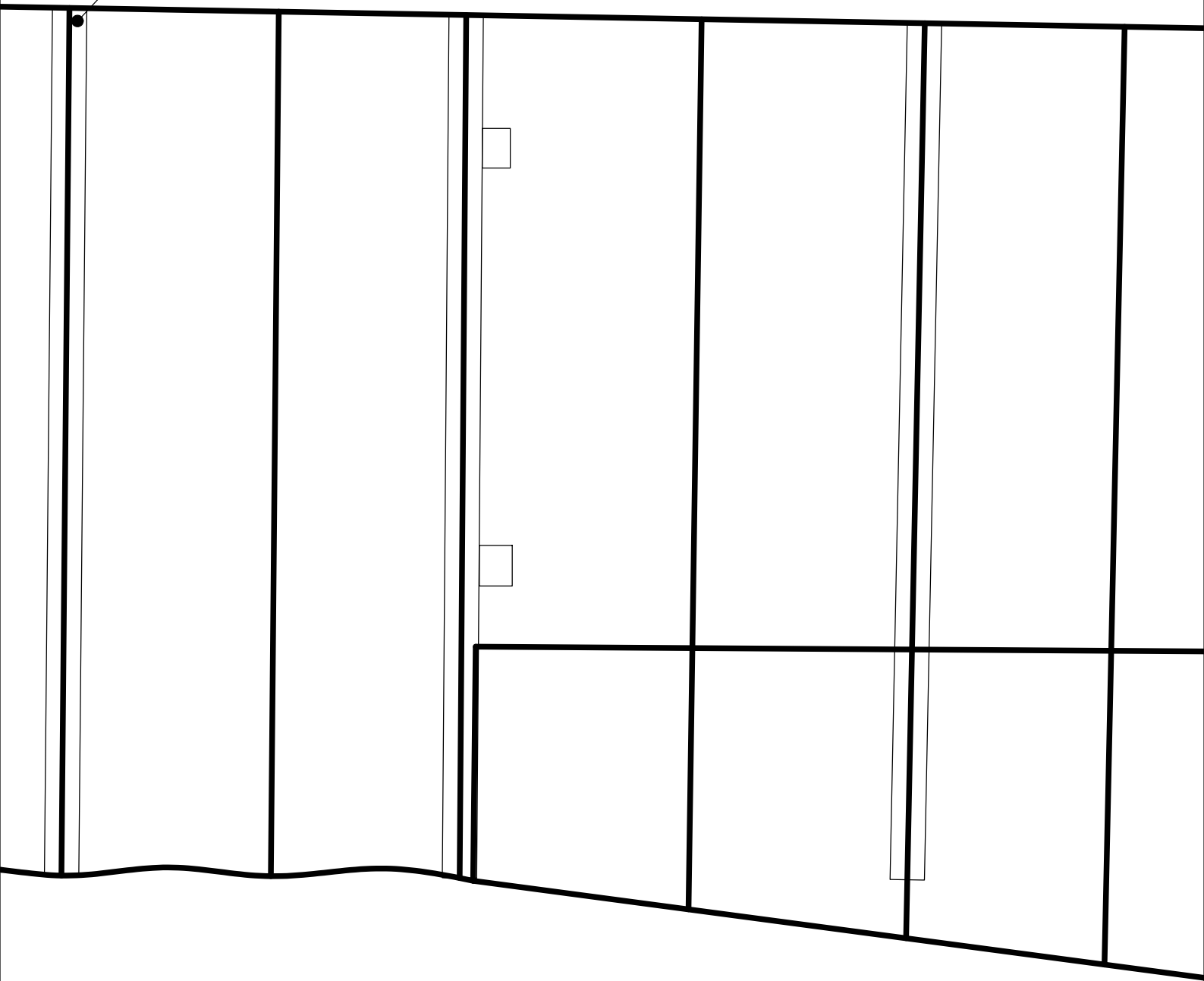

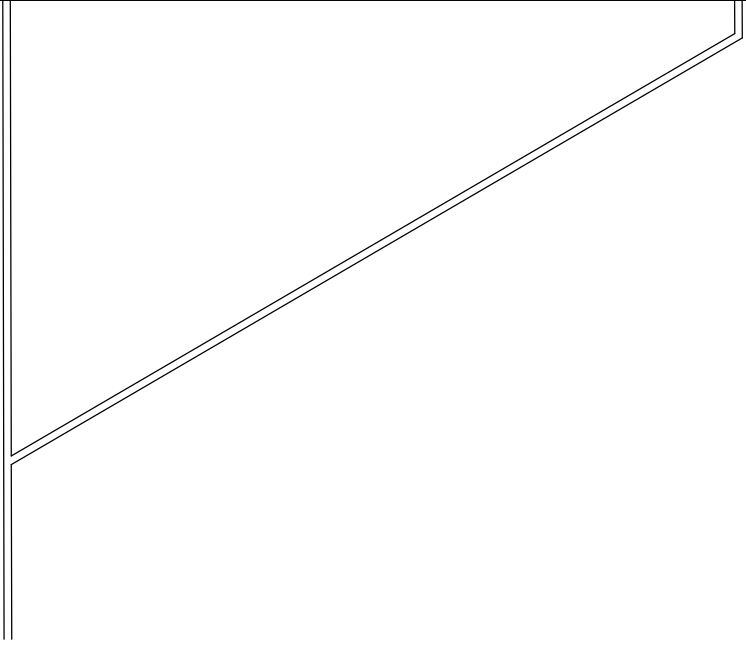
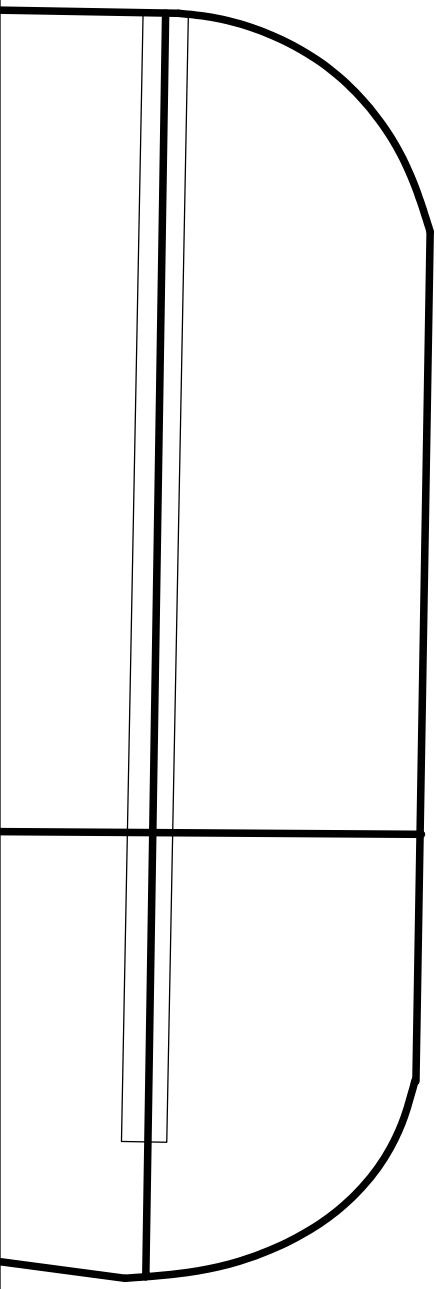

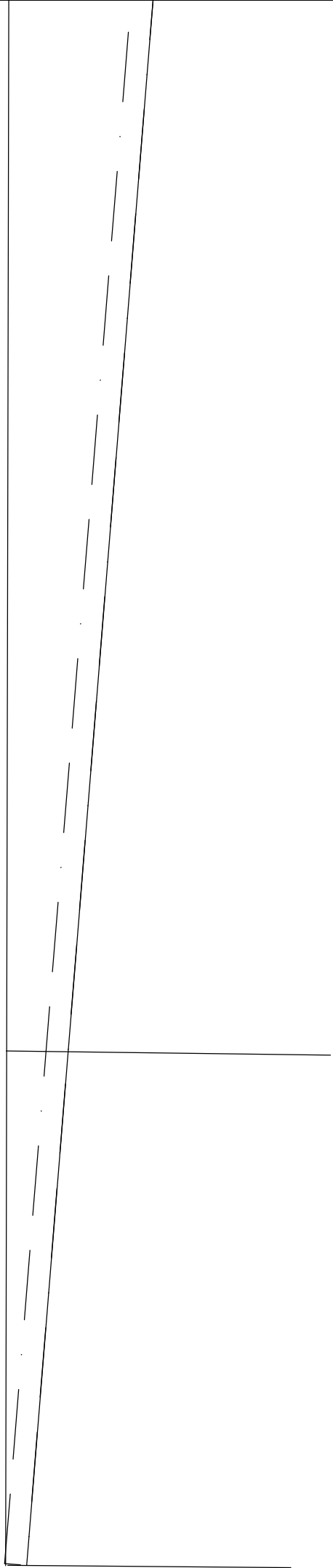

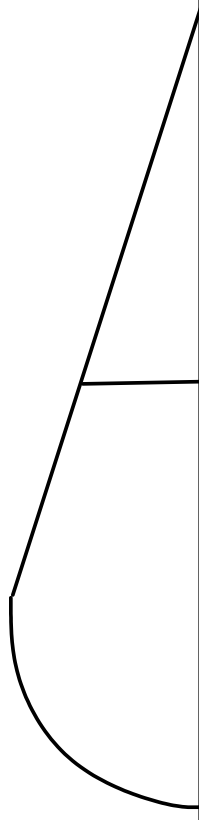
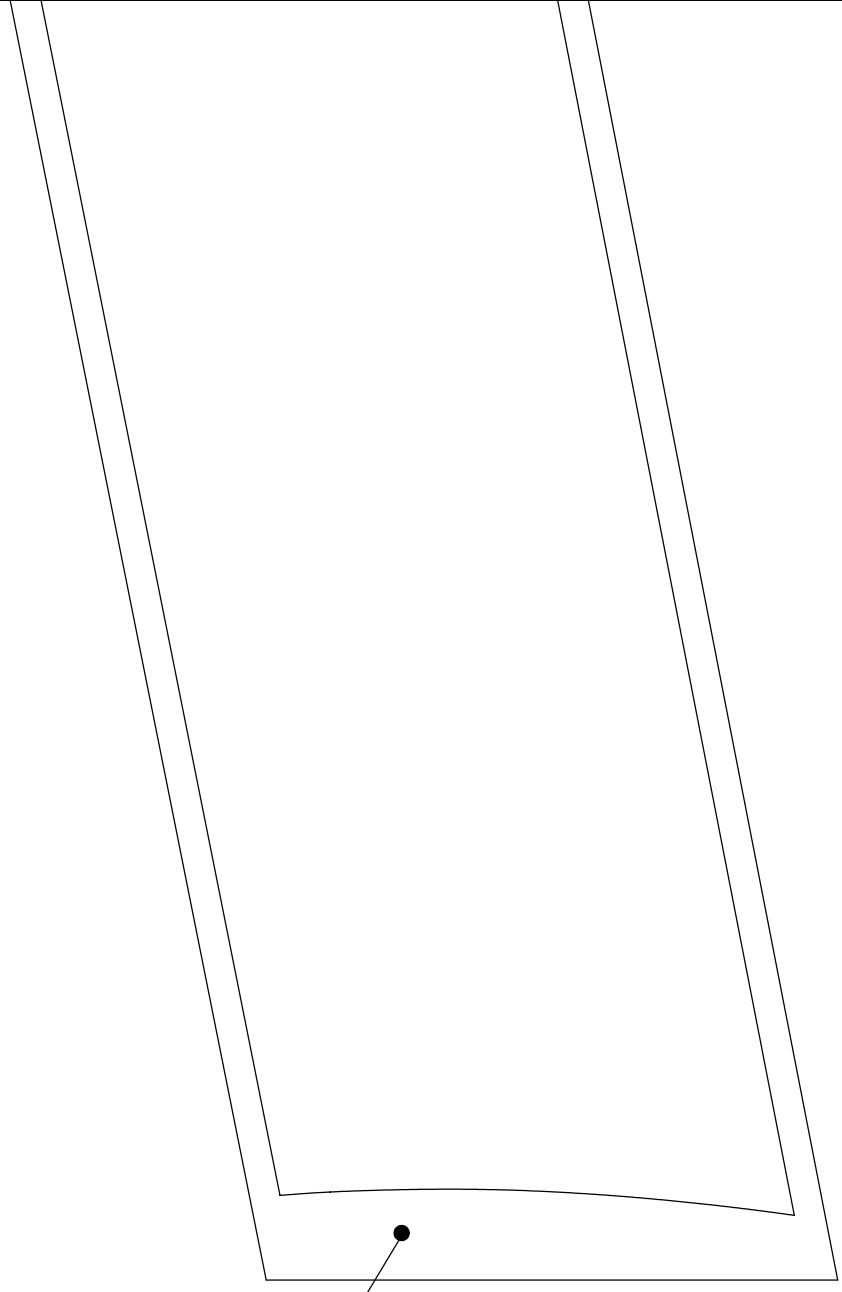

Mats entreplan Aile - Ctp 3mm ou balsa

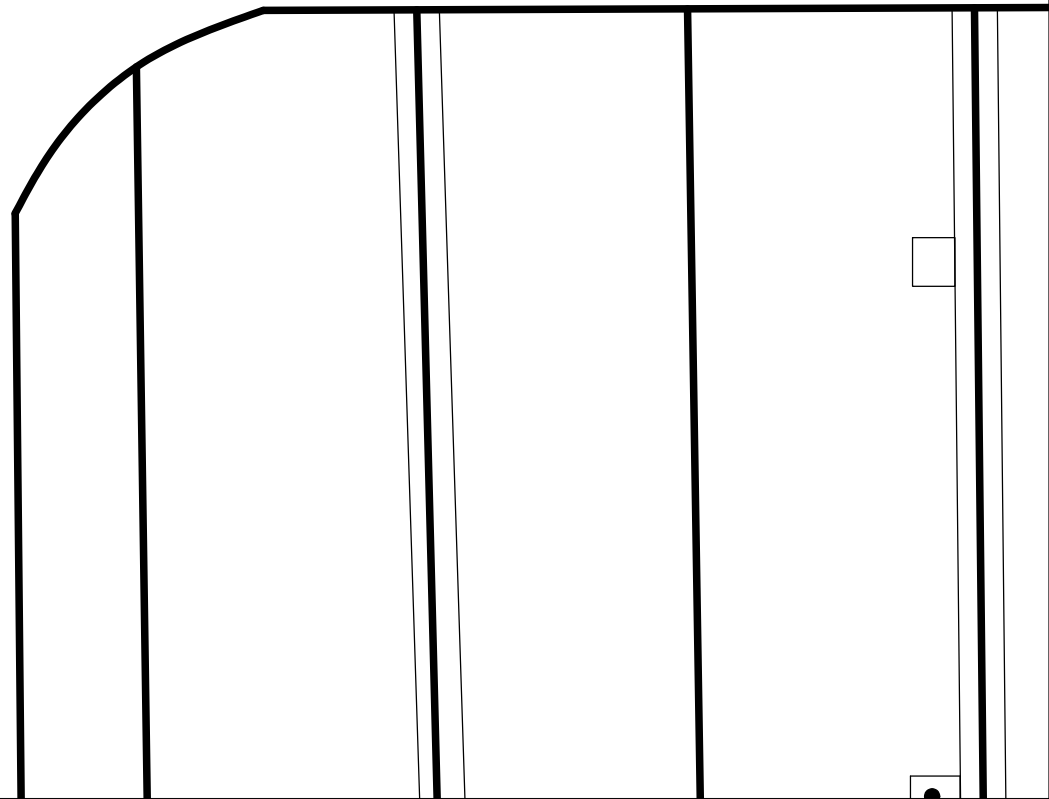

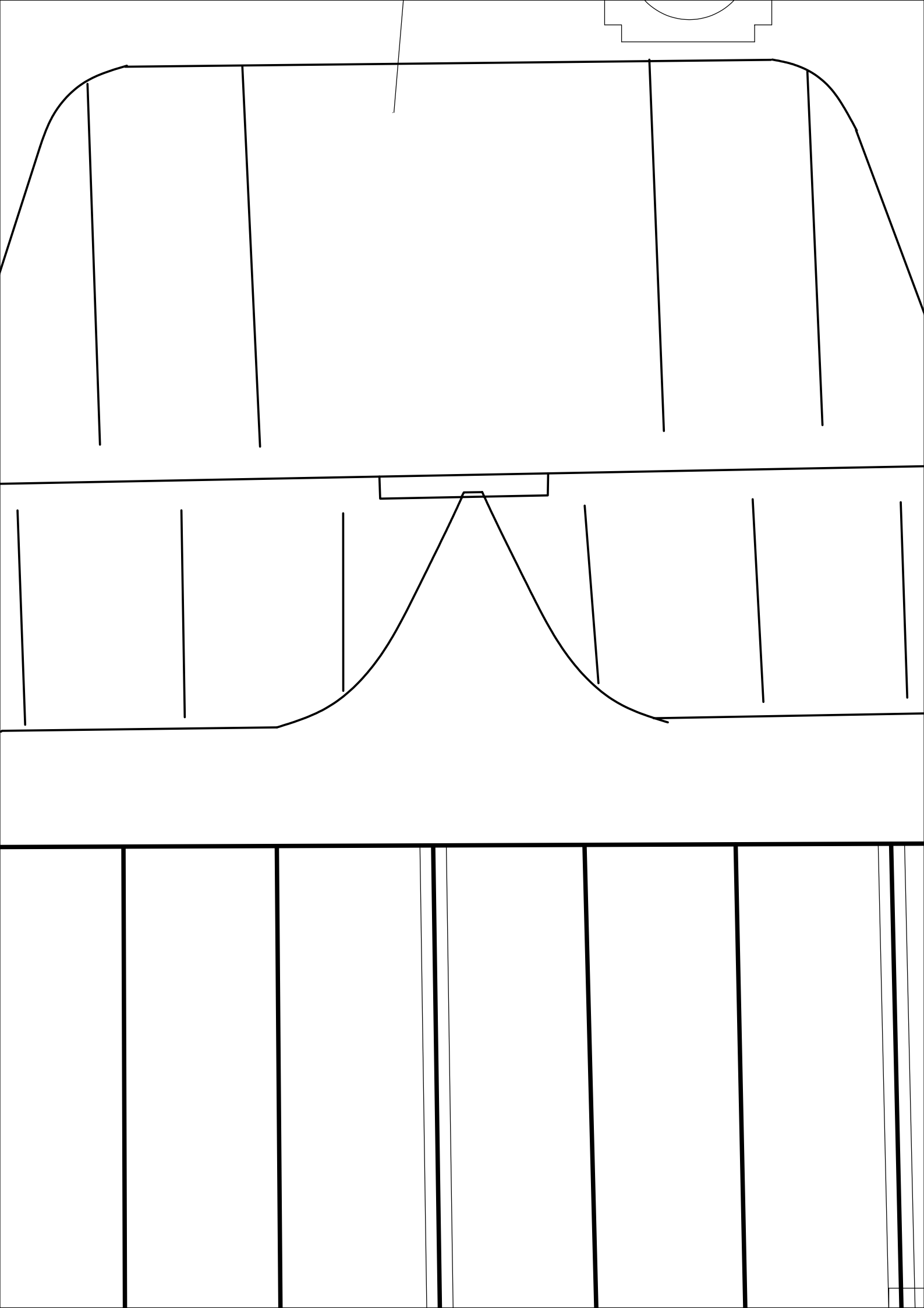

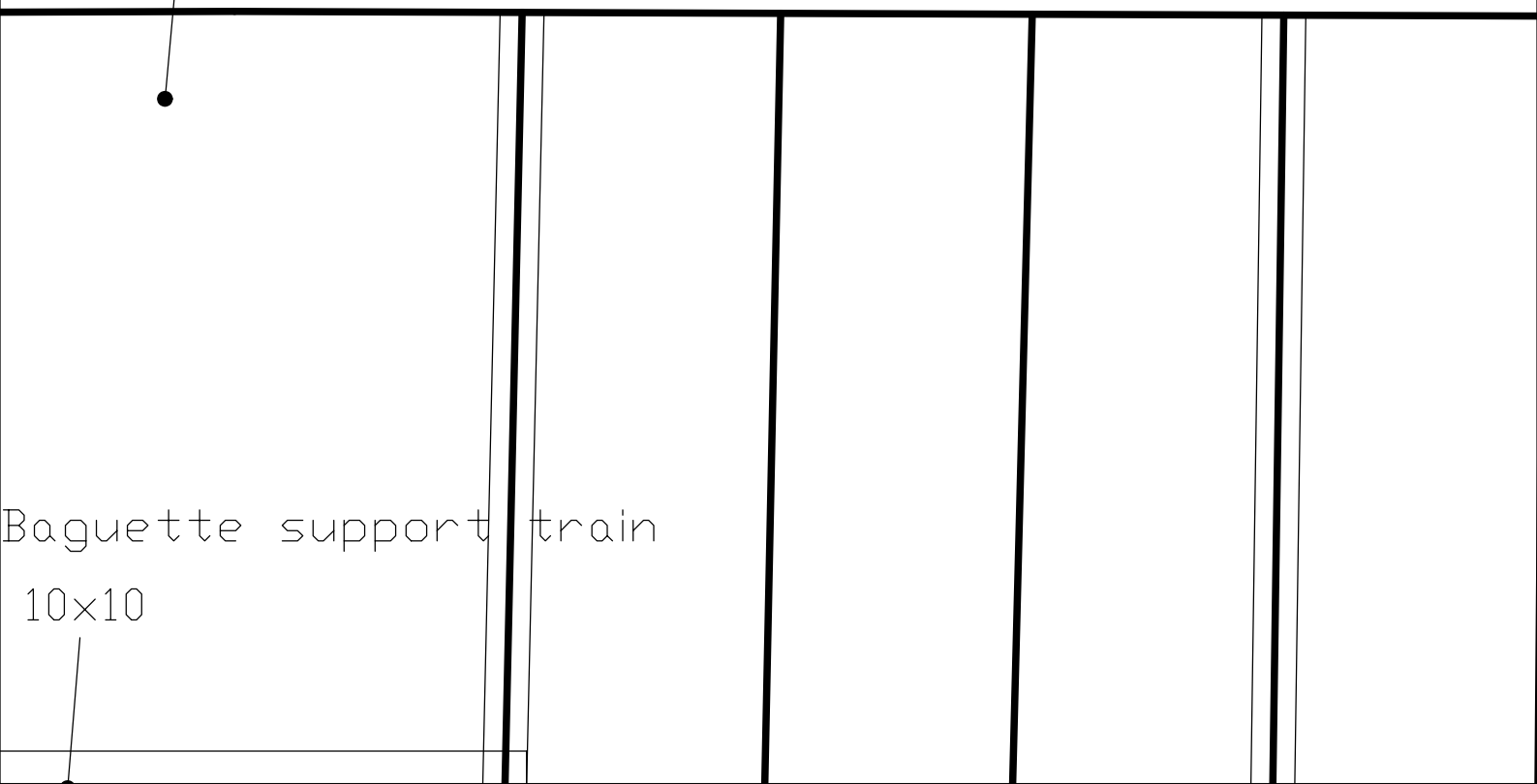
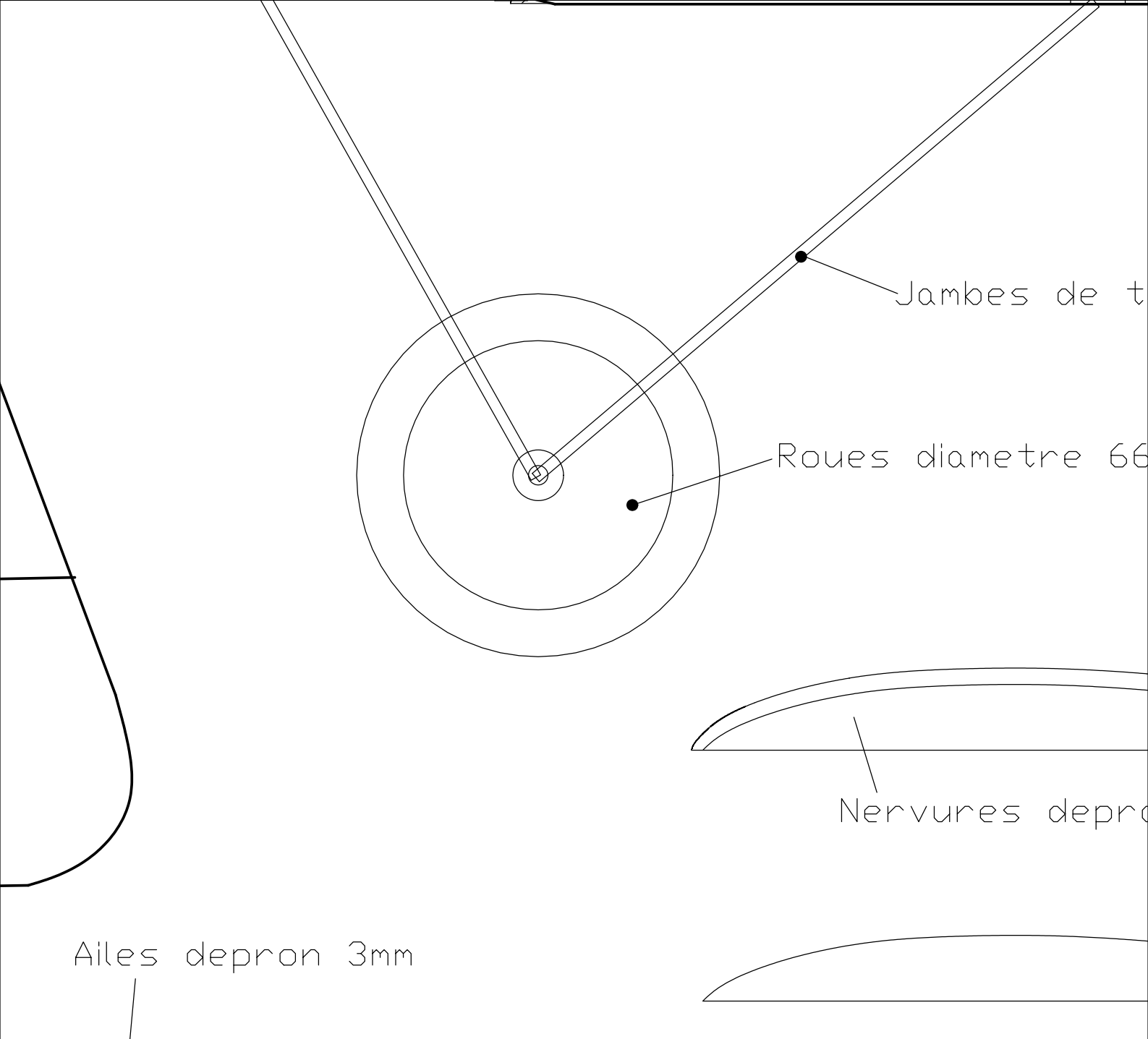

Couples depron 6mm

rain - CaP 2mm

mm env.

Extrados aile - depron 3mm

on 6mm



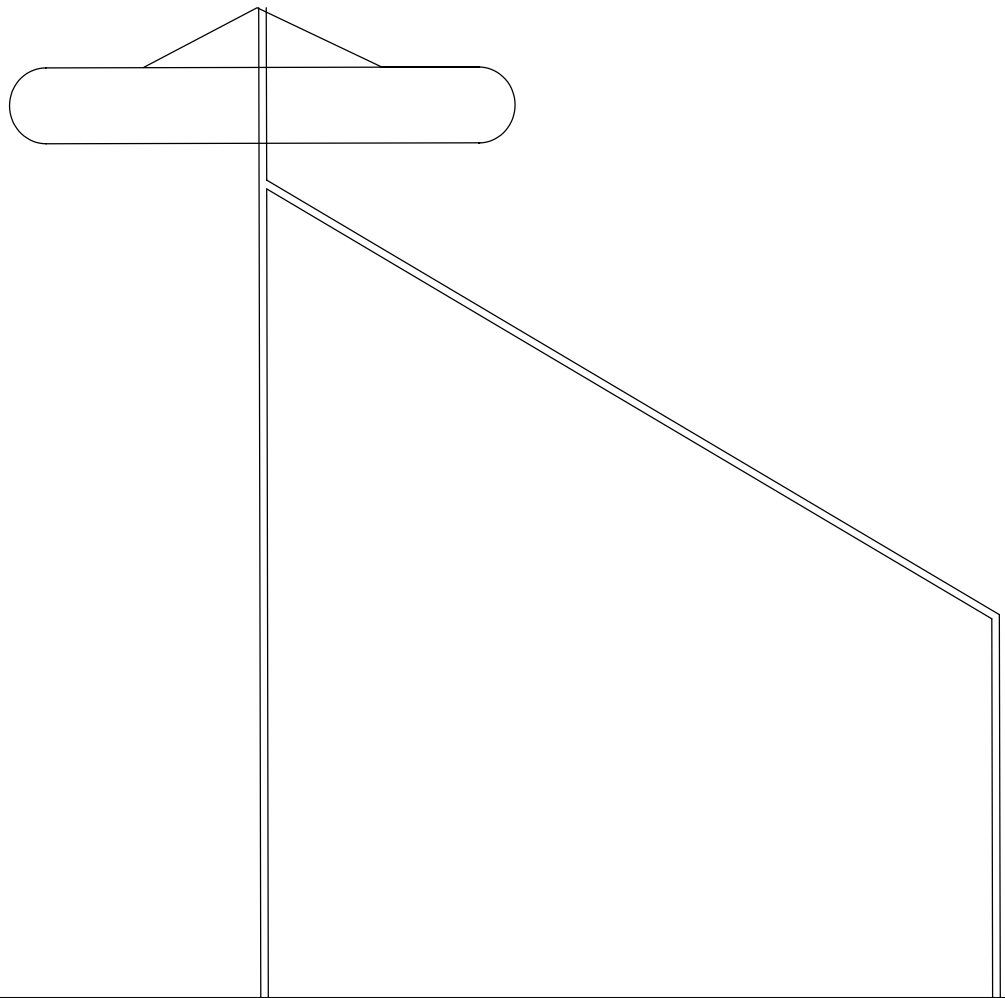
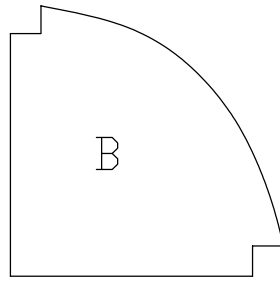
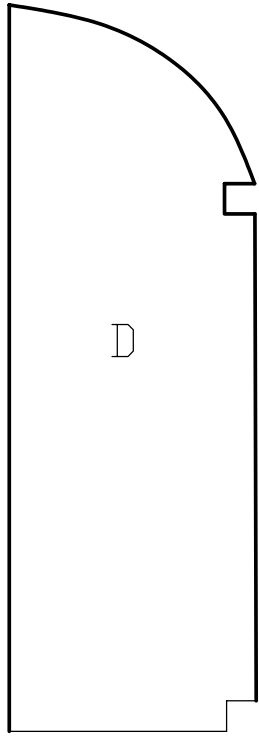
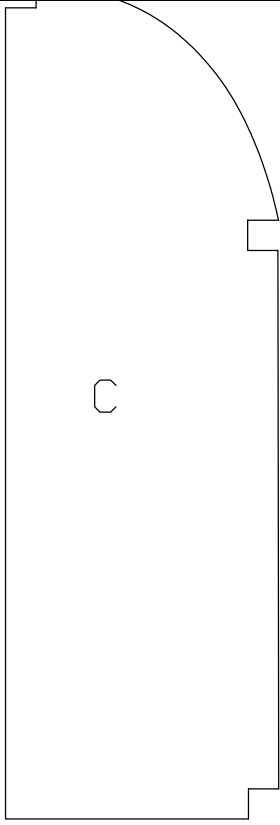

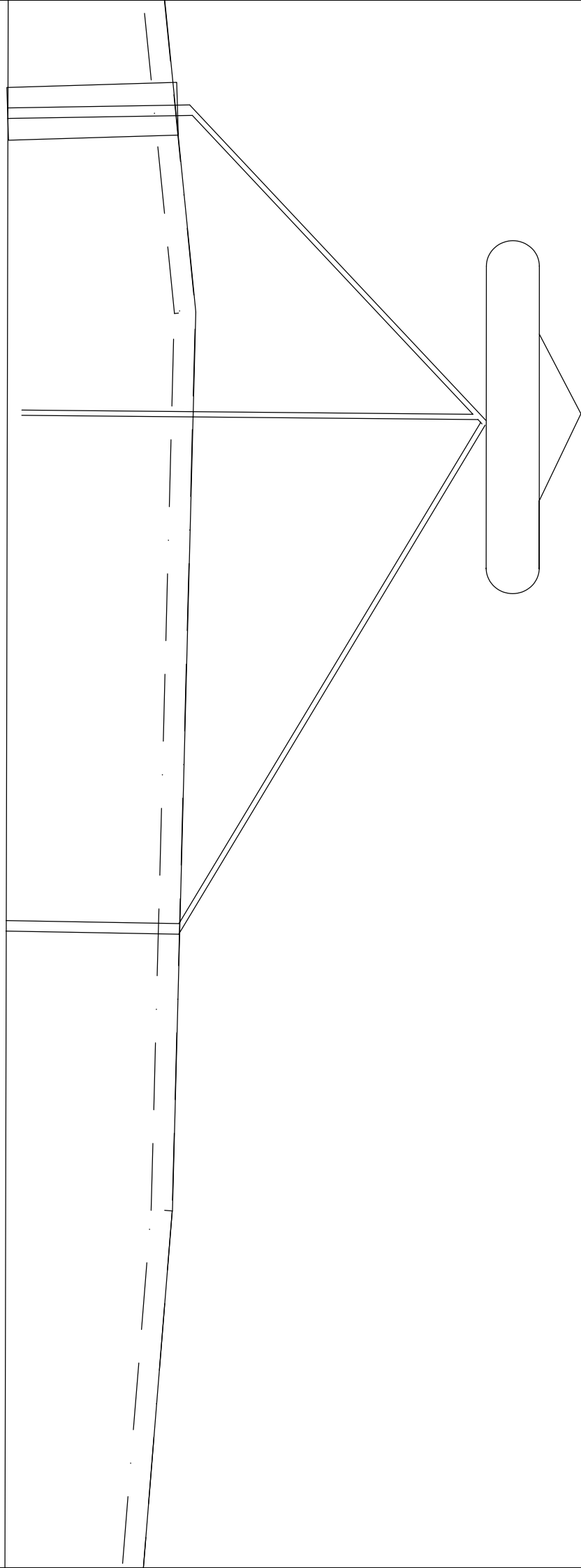

# Bohemia "B5"

Biplan pour le projet Age d'or : [Http:\\p](http://p)

Planche 1\1

Envergure : 87cms

Motorisation : Potensky - POT02 + helice 8x4

Dessin : Frederic Marie - Fredmarie@ifrnc

Not for commercial use without author's

Pas d'utilisation commerciale sans l'accor

projet.age.dor.free.fr

,5 + 7 elts

ance.com

consent

rd de l'auteur

Radiateur. Par

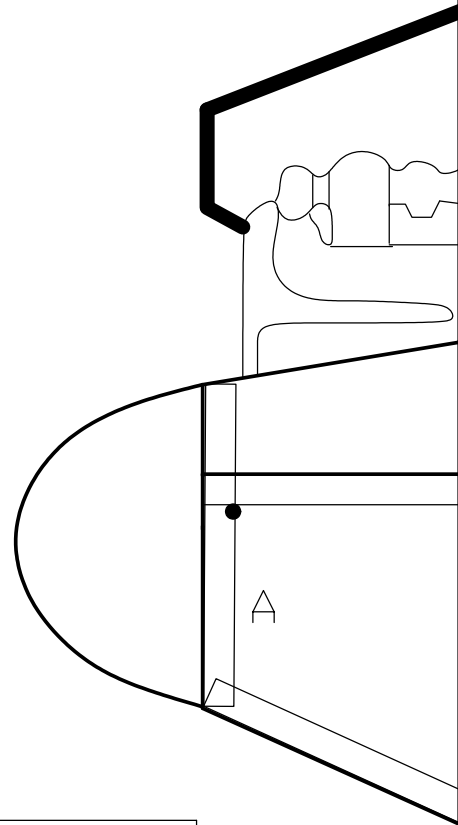
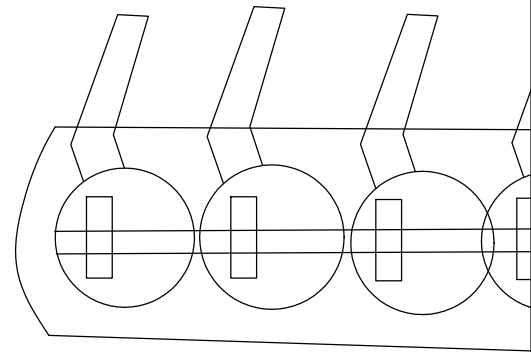

Stab depron 3mm

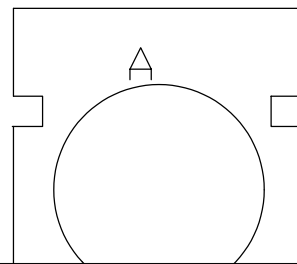

fois place sur le cote du fuselage Doublage nervure

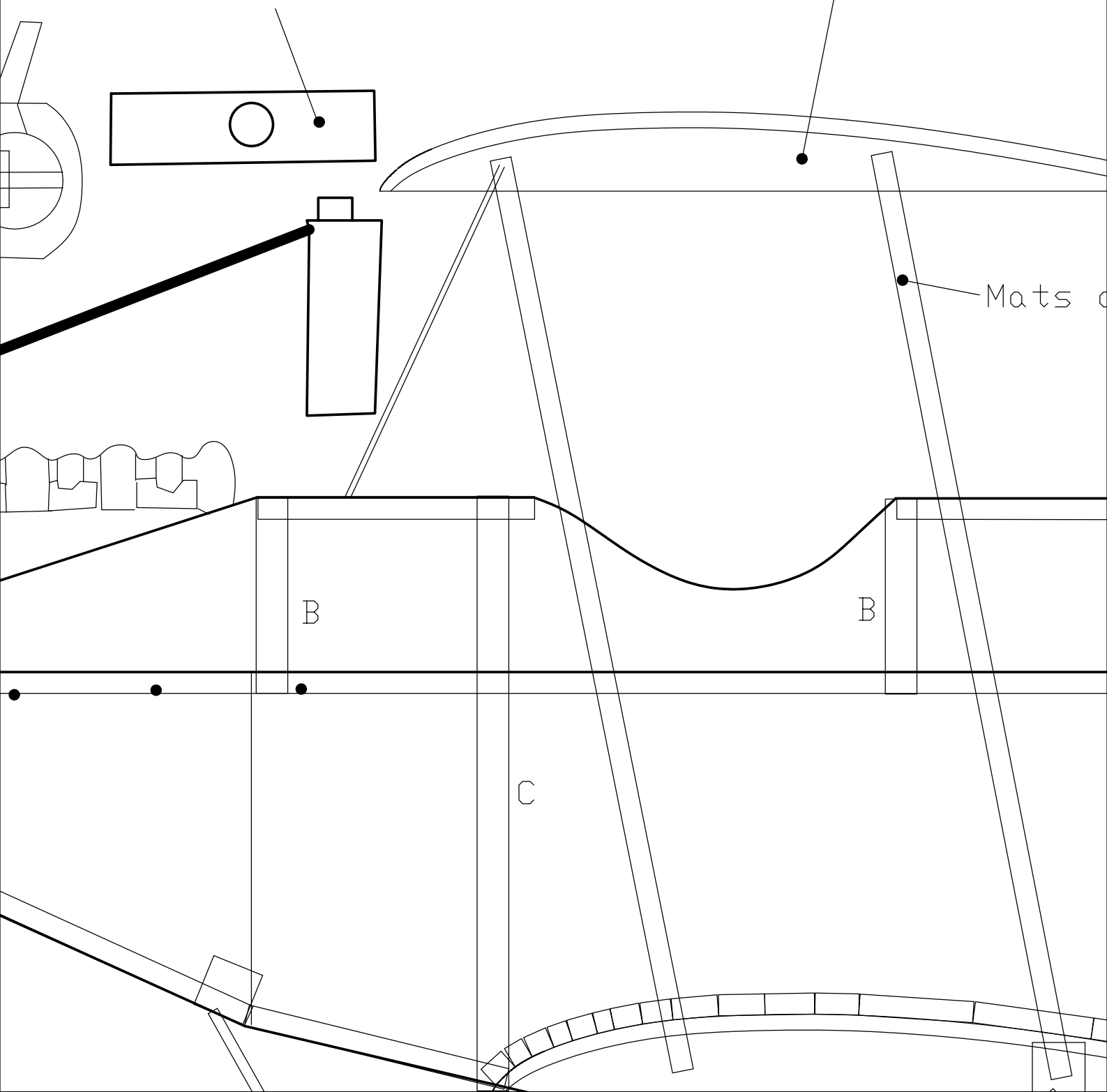

CTP 1mm - support collage mats

d'entreplan - CTP 3mm ponce

Dos fuselage - Depron 3

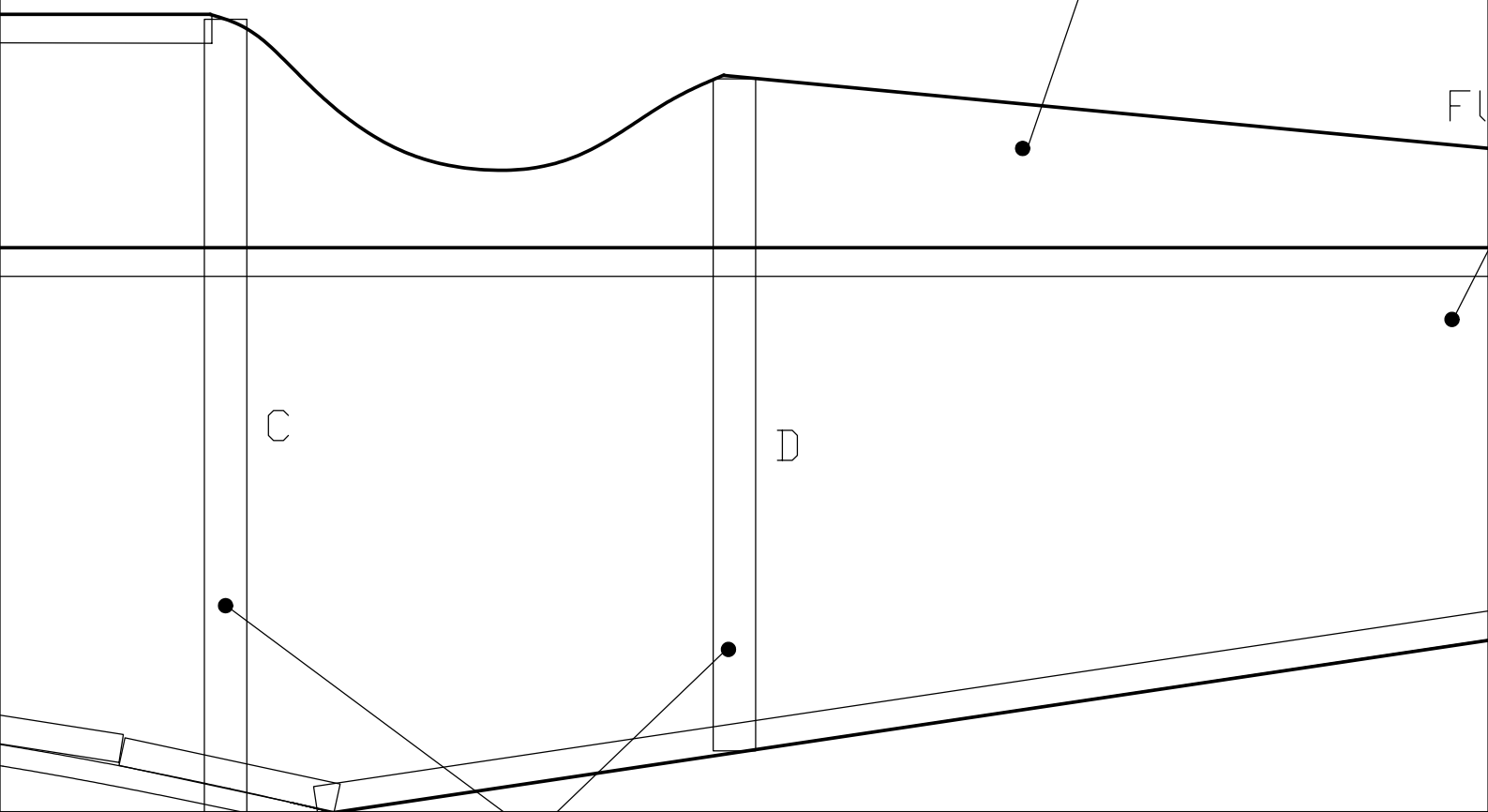

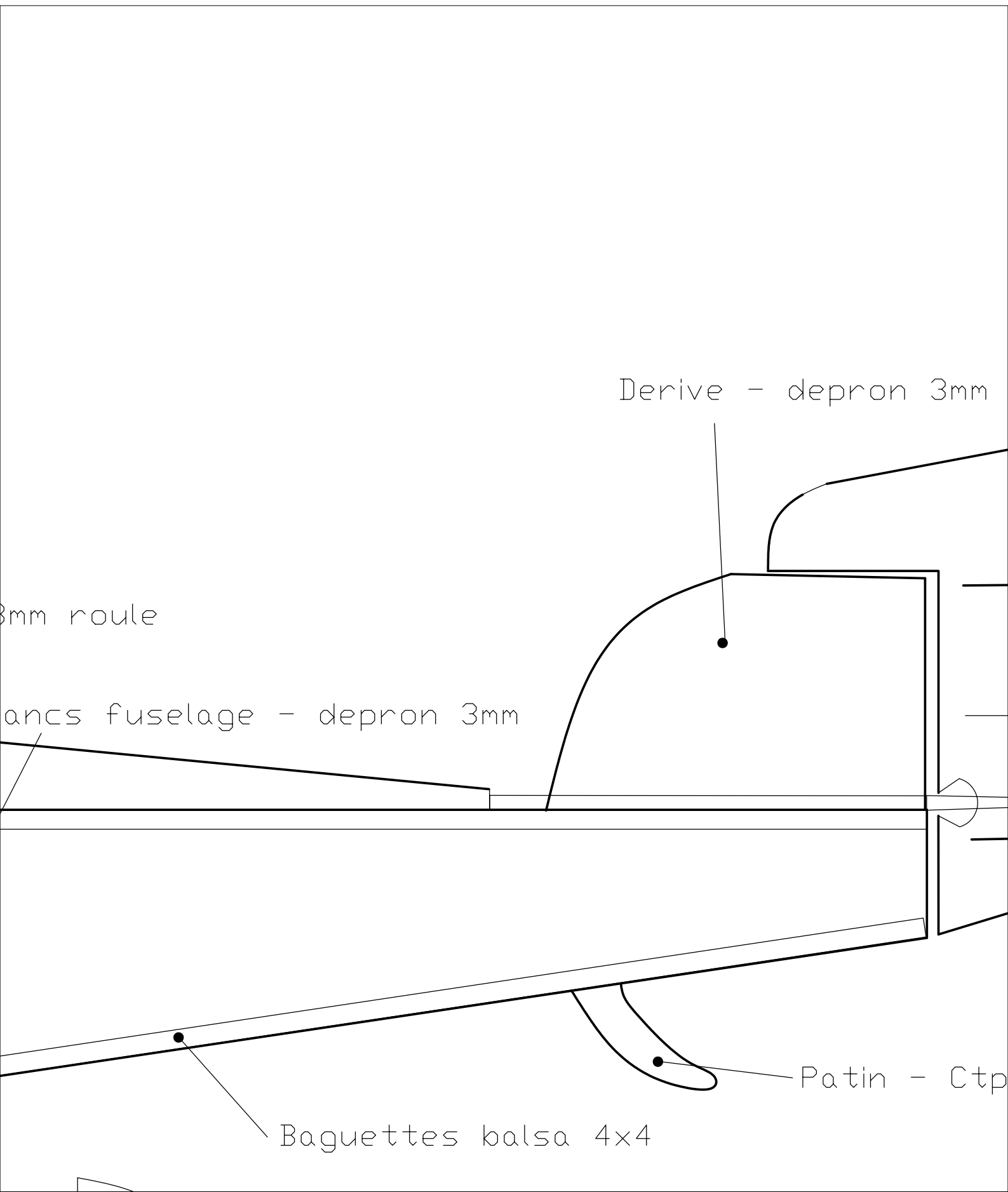

Derive - depron 3mm

3mm roule

Avants fuselage - depron 3mm

Baguettes kalsa 4x4

Patin - Ctp

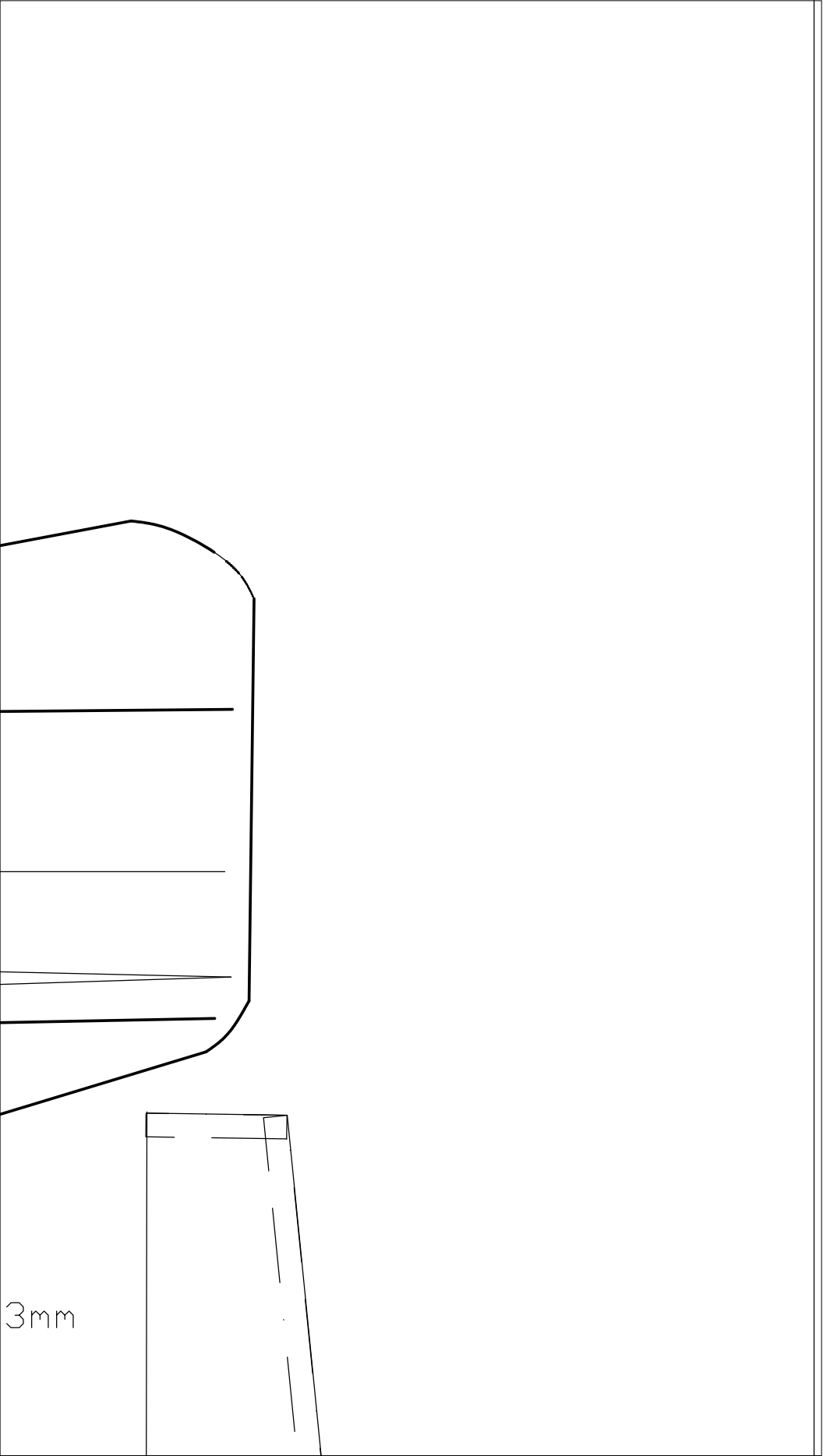

3mm